



Contents

Section A: Description and Operation 2
Section B: Basic Troubleshooting 4
Section C: Advanced Troubleshooting 5

Battery Charging Conditions

The following conditions may be observed during cold-start voltage tests until temperatures of electrical system components stabilize. The time it takes to reach optimum voltage and amps will vary with engine speed, load, and ambient temperature.

Maintenance/Low Maintenance Lead-Acid Battery:

Traditional lead acid batteries require lowest charge voltage of all vehicle battery chemistries. Battery cells must be maintained by periodically topping off with distilled water as required.

Maintenance-free Lead-Acid Battery:

Maintenance-free batteries are similar to Maintenance/Low Maintenance batteries, but may require slightly higher charge voltage.

Deep-cycle/Marine Maintenance-free Battery:

Charge acceptance of these batteries may display characteristics similar to maintenance-free batteries and may charge faster due to generally lower capacity relative to size.

AGM (Absorbed Glass Mat) Maintenance-free Battery:

These dry-cell batteries respond better than standard maintenance-free batteries. If battery state of charge (SOC) drops to 75% or less, batteries should be recharged to 95% or higher separately from engine charging system to avoid damaging charging system components and to provide best overall performance. Charge acceptance of these batteries may display characteristics similar to maintenance batteries, but may require higher charge voltage and will draw significant current (<100 amps) when under 50% SOC.

Lithium Battery:

Lithium batteries have unique charging characteristics that differ from lead acid. These batteries require charging systems configured specifically for lithium battery chemistries. Contact CEN for more information on lithium battery charging systems and components.

Testing Guidelines

Professional service technicians rely on the following guidelines when testing electrical components.

Voltage testing:

- Set meter to proper scale and type (AC or DC).
- Be sure to zero the meter scale or identify the meter burden by touching meter leads together. Meter burden must be subtracted from final reading obtained.
- Be sure the meter leads touch source area only. Prevent short circuit damage to test leads or source by not allowing meter leads to touch other pins or exposed wires in test area.
- Be sure to use CEN tools designed especially for troubleshooting CEN alternators when available.

Resistance (ohm) testing:

- Set meter to proper scale.
- Be sure to zero the meter scale or identify the meter burden by touching meter leads together. Meter burden must be subtracted from final reading obtained.
- Be sure meter leads touch source area only. Allowing fingers or body parts to touch meter leads or source during reading may alter reading.
- Be sure reading is taken when source is at 70°F. Readings taken at higher temperatures will increase the reading. Conversely, readings taken at lower temperatures will decrease the reading.
- Be sure to test directly at the source. Testing through extended harnesses or cable extensions may increase the reading.
- "OL" as referenced in this document refers to open circuit: "infinite" resistance, typically in very high kilo- or megaohm range depending on meter and settings.

Diode testing:

- Diodes allow current to flow in one direction only. Typical voltage drop in forward bias can range from 0.1-0.85V. Meter should read OL in reverse bias. Check meter user manual for meter-specific testing guidelines.

Voltage drop testing:

- Measure voltage between B+ on alternator or power source and B- (ground) on alternator or source. Record reading. Move to batteries or other power source and measure again between B+ and B- terminals on battery or other power source. The difference between the two readings represents voltage lost within circuit due to, but not limited to, inadequate cable gauge or faulty connections.
- Voltage drop measurements must be taken with all electrical loads or source operating.

Dynamic/Live testing (Connecting power and ground to component to test operation/function out of circuit):

- Connect jumper leads directly and securely to power source contacts of component being tested.
- Make any connection to power and ground at power supply or battery source terminals. Do not make connection at component source terminals, as that may create an arc and damage component source terminals.

Section A: Description and Operation



N1127 Alternator Description and Operation

The CEN model N1127 is a negative ground, hinge mount alternator rated at 28 volts, 140 amps. It is self-rectifying and brushless, and all windings and current-carrying components are stationary, so there are no brushes or slip rings to wear out.

Charging system is energized when regulator IGN pin receives an ignition/energize signal from the vehicle, usually via oil pressure switch or multiplex system (see page 3 for regulator features).

After receiving energize signal from vehicle, regulator monitors alternator shaft rotation and provides field current only when it detects the alternator shaft rotating at a suitable speed.

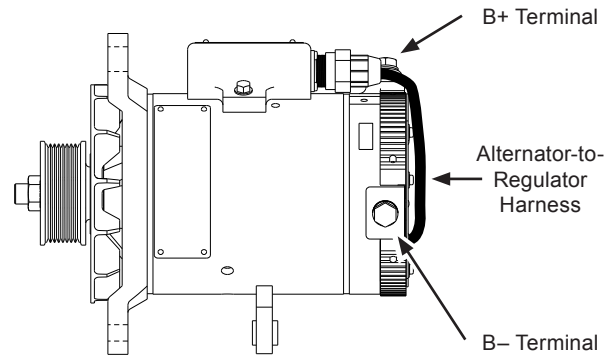

Figure 1: N1127 Alternator Connections

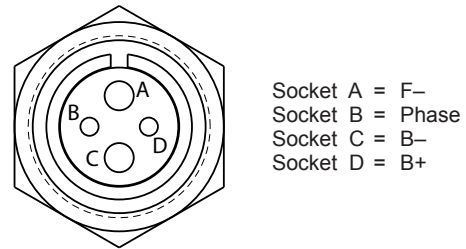

Figure 2: Alternator-to-Regulator Harness Plug Sockets

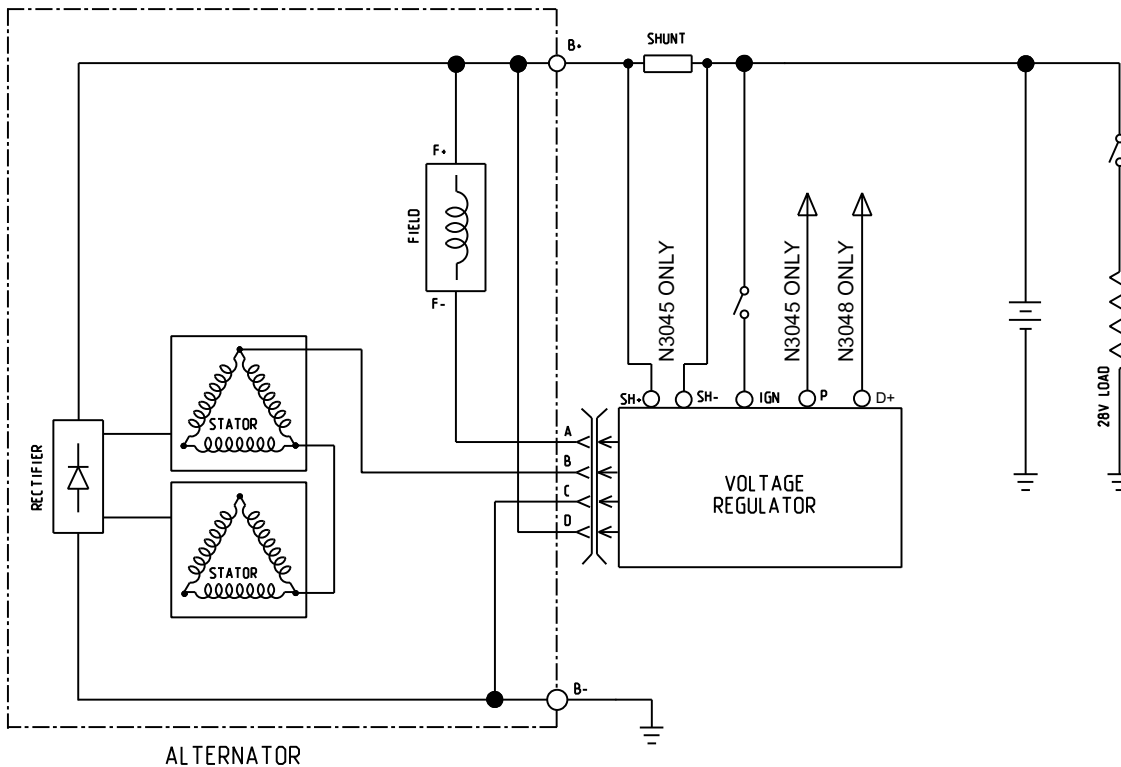

Figure 3: N1127 Alternator Wiring Diagram

(See model-specific characteristics drawing for detailed notes and information)



Section A: Description and Operation (cont.)

Voltage Regulator Description and Operation

CEN voltage regulators can be mounted directly on alternator shell.

Regulator features include:

- Adjustable charging voltage set points (See Table 1 and Figure 3).
- IGN terminal (required): Vehicle must supply battery voltage to IGN terminal to energize charging system (See Figures 4-6).
- Phase output (optional, N3045 only): P terminal taps AC voltage from alternator phase for use with relay or tachometer. Output is typically half of the output voltage at a frequency ratio of 10:1 of alternator speed (See Figure 5).
- D+ output terminal (optional, N3048 only): D+ circuit supplies DC battery voltage for optional use with charge indicator light or multiplex charge warning input (See Figure 6).
- Regulator SH+ and SH- terminals (optional, N3045 only) allows for alternator current limiting to 120 amps when connected to a 150A/50mV shunt on alternator output cable circuit (See Figure 5).

Setting	Battery Type
1	27.5V
2	28.0V
3	28.5V
4	29.0V

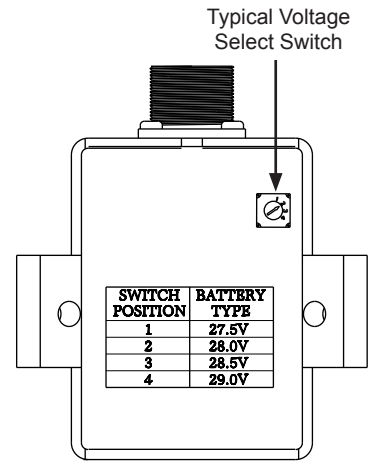

Figure 3: Voltage Select Switch and Set Points (all models)

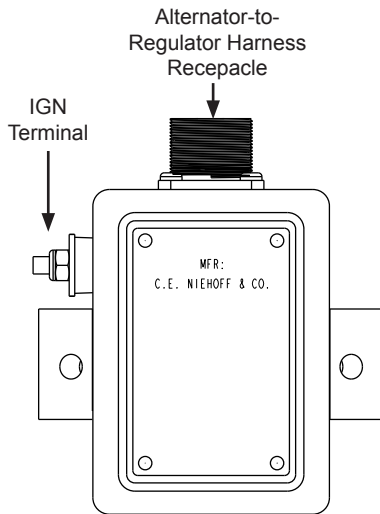

Figure 4: N3042
External Features

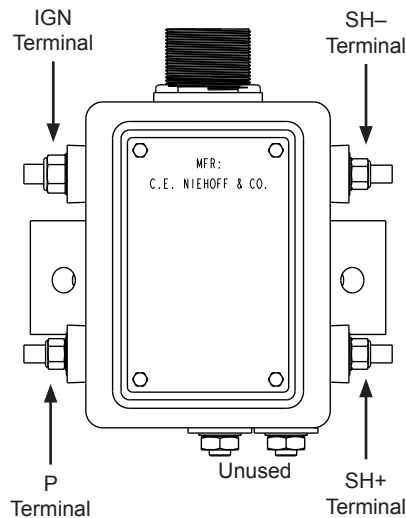

Figure 5: N3045
External Features

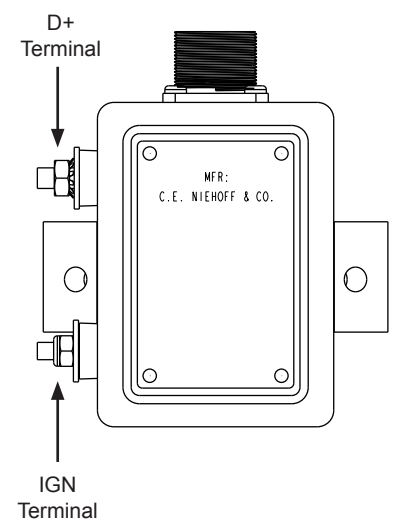

Figure 6: N3048
External Features



Required Tools and Equipment

- Digital Multimeter (DMM)
- Ammeter (digital, inductive)
- Jumper wires

Identification Record

Enter the following information in the spaces provided for identification records.

Alternator model number: _____

Regulator model number: _____

Voltage set points listed on regulator: _____

Preliminary Check-out

Check symptoms in Table 4 below and correct if necessary.

CONDITION:	CHECK FOR:
Low Voltage Output	Low battery state of charge. Load on system exceeds rated output of alternator. Faulty wiring or poor ground path. Faulty alternator or regulator. Wrong pulley installed. Wrong regulator installed.
High Voltage Output	Faulty regulator. Faulty alternator.
No Voltage Output	No energize signal at IGN terminal on regulator. Faulty alternator B+ terminal connection. Faulty alternator or regulator.

Basic Troubleshooting

1. Inspect charging system components for damage. Check connections at B– cable, B+ cable, and regulator harness. Check regulator terminal wiring from regulator to vehicle components. Repair or replace any damaged component before electrical troubleshooting.
2. Inspect vehicle battery connections. Connections must be clean and tight.
3. Inspect belt for wear and condition.
4. Determine battery type, voltage, and state of charge. Batteries must be all the same type. If batteries are discharged, recharge or replace batteries. Electrical system cannot be properly tested unless batteries are charged 95% or higher. See page 1 for details.
5. Connect meters to alternator:
 - Connect DMM red lead to alternator B+ terminal.
 - Connect DMM black lead to alternator B– terminal.
 - Clamp inductive ammeter onto alternator B+ cable.
6. Operate vehicle and observe charge voltage. Charge voltage should increase and charge amps should decrease. Battery is considered fully charged when charge voltage is at regulator set point and charge amps remain at lowest value for 10 minutes.
7. If voltage is at or below regulator set point, allow charging system to operate for several minutes to normalize operating temperature. If charge voltage does not increase within 10 minutes, go to Chart 1 on page 5.

CAUTION *If voltage exceeds 32 V, shut down system immediately. Damage to electrical system may occur if charging system is allowed to operate above 32 V for more than 3 seconds.*



Chart 1: No Alternator Output – Test Charging Circuit

- TEST MEASUREMENTS ARE TAKEN ON HARNESS PLUG AT ALTERNATOR. TAKING MEASUREMENTS FROM AN EXTENDED HARNESS PLUG MAY AFFECT RESULTS.
- FOR REMOTE-MOUNTED REGULATOR, CHECK CONDITION OF HARNESS FUSES BEFORE TROUBLESHOOTING.
- BEFORE STARTING DIAGNOSTIC SEQUENCE, VERIFY THE FOLLOWING AND REPAIR/REPLACE IF NOT TO SPEC:
 - BATTERIES FOR STATE-OF-CHARGE (25.0-28.0 V), CONDITION, AND SECURE CONNECTIONS.
 - MASTER BATTERY SWITCH FOR FUNCTION.

CAUTION MAKE SURE METER PROBES DO NOT TOUCH OTHER PINS/SOCKETS AND CAUSE AN ARC THAT MAY DAMAGE PINS/SOCKETS AND HARNESS WIRING.

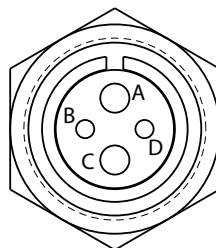
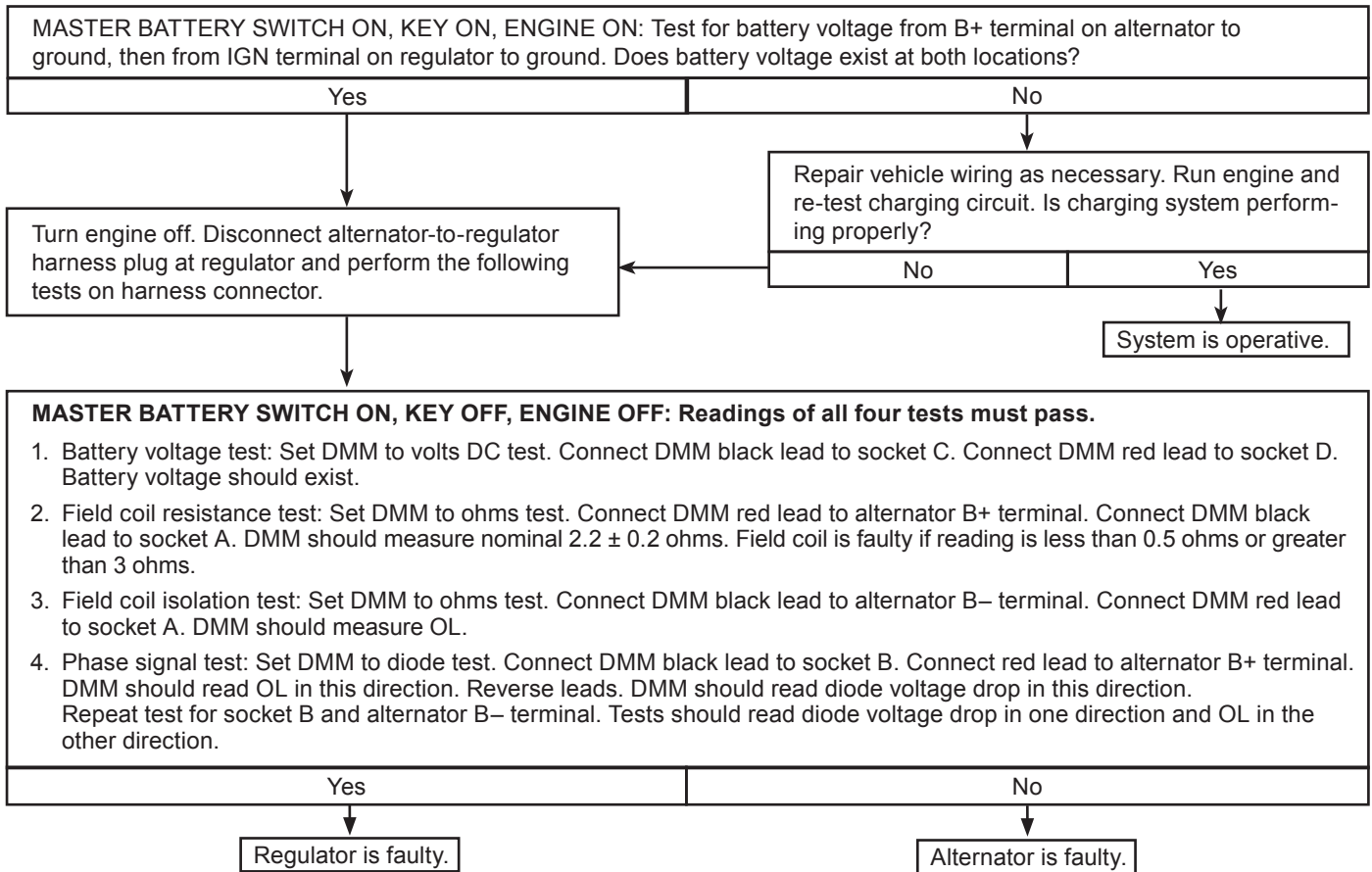

Socket A = F-
 Socket B = Phase
 Socket C = B-
 Socket D = B+

Figure 7: Alternator Harness Socket Connections



If you have questions about your alternator or any of these test procedures, or if you need to locate a Factory Authorized Service Distributor, please contact us at:

C. E. Niehoff & Co. • 2021 Lee Street • Evanston, IL 60202 USA
TEL: 800.643.4633 USA and Canada • TEL: 847.866.6030 outside USA and Canada • FAX: 847.492.1242
E-mail us at service@CENiehoff.com